

Door Seals

FD30



FD30S

Must have fin or brush seal



For single acting, single leaf up to 926x2040mm any 15x4mm CERTIFIRE approved intumescent seal may be used.

For single acting pairs.

Use 15mm x 4mm Lorient 617 in legs
Use 20mm x 4mm Lorient 617 in head
Use 2 off 10mm x 4mm Lorient 617 in meeting stiles
(the meeting stile seals must not oppose each other)

Hinges & Screws

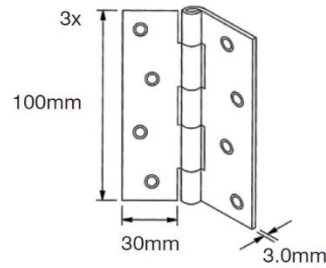

Hinges must be CE marked for use on a fire door. Top and bottom hinges must be 150mm from end of door and 3rd hinge central

Intumescent protection is not required behind hinge blade.

Use no.8 or 4mm, x 32mm screws.

Lock or Latch

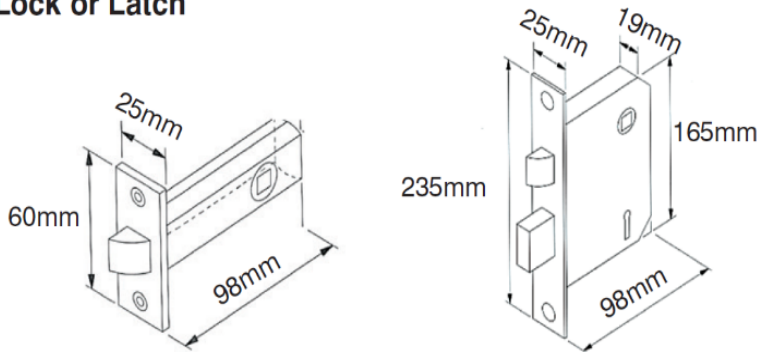

Lock or latch must be CE marked for use on a fire door

Latch is optional if closer fitted

Body of mortise lock must always be faced with 1mm intumescent sheet

Closers

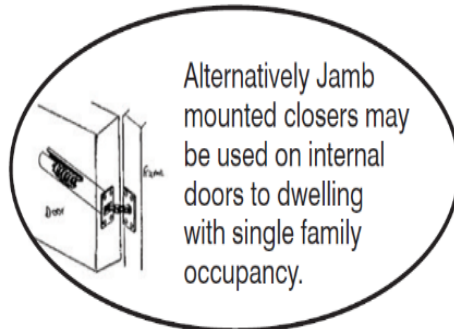
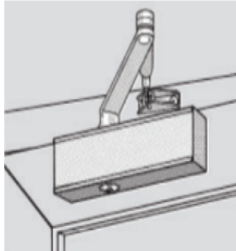

For more information on installation please call **PREMDOR** Technical Helpline on 0844 209 0008



Any CERTIFIRE approved closer, may be fitted subject to restrictions on use outlined the Certifire approval for the closer.

Installation Instructions CF380

These instructions must be followed. Failure to do so will mean that this will no longer be a Certifire approved fire door



CF 380
PREMDOR BARNSELY
Tel: 0844 209 0008

Fire Door Certification invalid unless installed and maintained exactly in accordance with Manufacturer's instructions and this label is retained unmarked and not removed.



To keep certification never remove this tamper evident label from top edge of the door leaf

CONFIGURATIONS

✓ = Allowed ✗ = Not Allowed

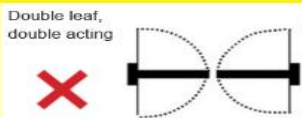
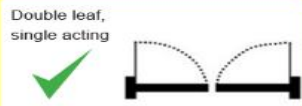

Glazing & Air transfer grills

✗ = Not Allowed



Glazing and cutting apertures for air transfer grills may ONLY be carried out by door manufacturer or Licensed Processors

Storage

Store in dry conditions on 3 equally spaced level bearers
Polythene wrapping must remain on the door until immediately before hanging.

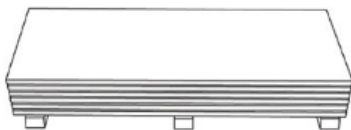

To ensure good performance, particularly in new build situations, do not install in buildings immediately after plastering or other wet trades.

1/ Keep doors half open.

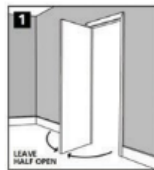

Leave Half Open

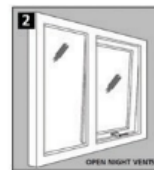

Open Night Vents

2/ Open trickle vents and set sash windows on night vent position 24 hours per day.

This will ensure a constant flow of dry air from outside, taking away any damp air from inside the property.

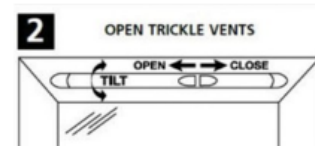

3/ We do not recommend the use of gas fired heaters in new build situations due to the release of carbon dioxide & water vapour thus adding more moisture to the air

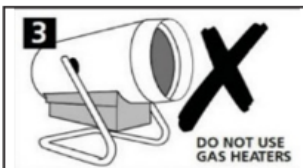

Finishing

To help seal the door and reduce the risk of distortion, all surfaces of the door must be painted or varnished immediately after the door is removed from wrapping or delivered to site.

Door Frame

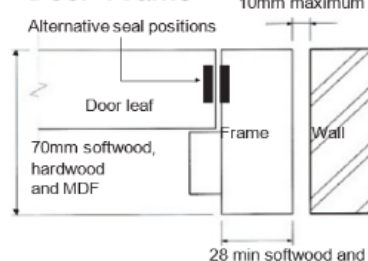

The frame to wall gap must be filled with mineral fibre and or intumescent mastic.

Allowed door frame materials: Hardwood 440kg/m³ minimum, Softwood 440kg/m³ minimum, MDF 700kg/m³ minimum

Hinge Positions & Fixing Locations

4mm max frame to door gap on long edges and top

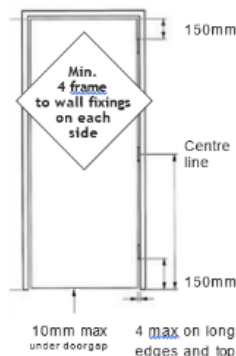

NOTE: Where FD30S is required the maximum gap under door shall be 3mm unless a threshold seal is fitted.

Trimming the door

Top of door may be trimmed by up to 3mm to allow it to fit in an out of square frame, but in doing so the Certifire label must not be removed.

